

The Industry Leader in
Alkaline Water Ionizer Technology

PREMIUM ALKALINE WATER IONIZER USER MANUAL

PRIME-L SERIES



**HIGH PERFORMANCE
PREMIUM ALKALINE WATER IONIZER**



PrimeWater



PRIME-501R / 701R / 901R / 1101R / 1301R
With PRIME FAUCET

FC CE KFDA

The Industry Leader in
Alkaline Water Ionizer Technology
PREMIUM ALKALINE WATER IONIZER



**HIGH PERFORMANCE
PREMIUM ALKALINE WATER IONIZER**

Product Features

- MAX Cool - Super Cooling System
- MAX Plates - New Larger Titanium/Platinum Plates
- MAX Yield SMPS Power System - generates up to 450 watts
- Premium Multi-stage media ultra dual filtration system
- New Larger ultra efficient electrolysis chambers
- Sleek & Compact design
- Smart & Premium Touch button and wide display panel
- All Prime Water Alkaline Water Ionizers are made with BPA Free tubing
- Complete auto-diagnosis system

Table of Contents

Safety Guide 04-06

Installation of parts Guide 07

Parts of the Ionizer 08-09

Display & Control Panel Guide 10

Installation to Faucet(Counter top) 11

Installation Direct to Cold Water Line 12

Operation Method 13

Parts of the Faucet 14

Faucet Display & Control Panel Guide 15

Faucet Installation Guide 16-17

Faucet Operation Method 18

Internal Filter Replacement 19

Filter Composition 20

Common Problems and Solutions 21

Product Specifications 22

Function Options Guide 23

Explanation of Ionized Water 24

Alkaline & Acidic Water Usage Guide 25

Uses for Ionized Alkaline Water 26

Uses for Acidic Water 27

Frequently Asked Questions 28-30

Limited Warranty Information 31

Before installation or operation of the ALKALINE WATER IONIZER, read this instruction manual completely.

Note-Some parts may have been altered to improve product quality function or ease of use.



Safety Guide - Read Completely

Before installation or operation of the PRIME WATER ALKALINE WATER IONIZER, read this instruction manual completely.





Note-Some parts may have been altered to improve product quality function or ease of use.

Symbols

Refer to the following key symbols and indicators throughout the manual.





-  Improper use may cause bodily injury
-  Improper use may cause structural damage to the unit or physical injury
-  As with most electrical appliances, electrical parts in this ionizer are electrically live even when switch is off

Indications

-  Caution, Warning, Danger symbol
-  Information on prohibited functions and uses
-  Make note of important information
-  Do not open as it may cause electric shock or other injury
-  Disconnect power plug in case of malfunction









Improper use may cause bodily injury

If you have never consumed alkaline water – start off with the lowest alkaline setting (level 1) to begin with. Let your body adjust slowly and naturally for 4-7 days. After this initial adjustment period, you may gradually increase the alkalinity of the water.





-  Do not drink alkaline water if you have achlorhydria.
-  Consult a health care provider before using acidic water if you have:
 - Sensitive skin
 - Allergies
-  Only use potable drinking water in your ionizer.
-  If on hard water please ask about pre-treatment options
-  Well water and water from smaller systems should be tested for safety before using with an ionizer, and may require pre-filtering.

Safety Guide - Read Completely

 As with most electrical appliances, electrical parts in this ionizer are electrically live even when switch is off













-  This machine should not be repaired or otherwise disassembled by any unauthorized person as it may cause electrical fire or shock, and will void the manufacturer's warranty.
-  Do not place the machine in humid areas such as bathrooms.
Do not clean this machine by spraying the ionizer with water as it may cause electrical shock.
-  Power cord should not be touched with wet hands.
If the ionizer machine falls in to water-
 1. Unplug power cord from electrical outlet
 2. Wipe the machine down and place in shaded area
 3. Contact your dealer
-  Use only(110V) in the U.S.A. and Mexico.
Most other countries require (220V). The power cord cannot be altered from manufacturer's specs.
Do not crimp or staple the power cord as it could cause electrical shock.
-  Power cord should be plugged directly into an electrical outlet.
Do not connect multiple appliances into a single power receptacle.
-  Dusty or dirty electrical outlets may cause safety issues.
-  Bending, twisting, pulling or putting heavy objects onto the power cord may cause electrical problems including fire.
-  If power cord, plug, or electrical outlet are damaged, discontinue use immediately.

Improper use may cause bodily injury

-  Place machine in an upright position only.
-  Do not install this unit in direct sunlight or near a heater, fireplace or other heat source.
-  Do not use water with a temperature of over 95 degrees Fahrenheit or 35 degrees Celsius.
-  If wall mounted, secure firmly and correctly.

Safety Guide - Read Completely

 Improper use may cause structural damage to the unit or physical injury

-  If not used for several days, run water through the unit for 1 to 3 minutes before starting.
-  If inexperienced with drinking Ionized Alkaline Water, users are encouraged to start with level 1.
-  Store Ionized Alkaline Water in an air-tight glass container and refrigerate for up to 2 days.
-  Do Not Drink Acidic Water.
-  Do Not store Alkaline or Acidic Water in metal containers.
-  Aluminum and brass containers will be tarnished by Alkaline and Acidic Water.
-  When handling the pH test (Reagent drops)
 1. Keep away from eye area.
If eyes become irritated, flush thoroughly and consult a doctor.
 2. If accidentally swallowed, drink water and consult a doctor.
 3. Store in an airtight container away from the reach of children.
 4. Drops are flammable. Keep away from children.
-  Do not block the unit vent as it can cause overheating and/or electrical problems.
-  Do not block the water passage or tubing.
-  Do not use benzene, thinner, or chemicals to clean the unit as it can damage the housing.
-  If the machine will not be used for several days....
 1. Unplug the power cord from the electrical outlet.
 2. Turn off the water valve to avoid leaking.
 3. Remove filters, drain and place in refrigerator in plastic bags.
-  Customers in hard water areas may need additional treatment otherwise risk voiding their valuable warranty. If unsure about the quality of your water please contact a water specialist.

Installation of Parts Guide

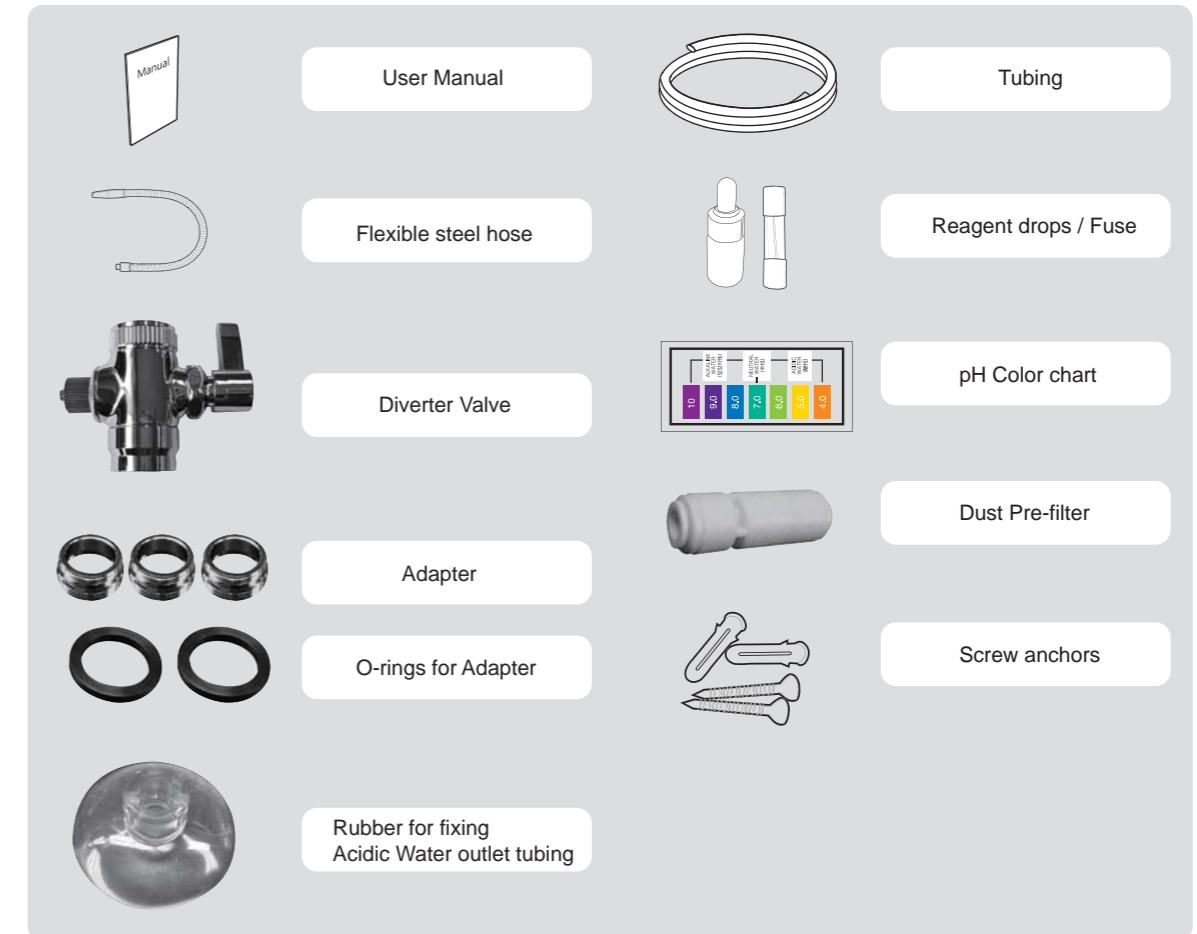

REGULARLY CHECK AND CLEAN YOUR PRE-FILTER

Keeping the pre-filter clean is critical to the proper operation of your ionizer. First ensure your water supply is turned off. Then remove the pre-filter by pressing on the end of the fitting and pulling out the hose at the same time. Rinse out the filter thoroughly to remove any built up particulate. Rinse from both sides. Reinstall it. Clean the filter in this way any time you notice a decreased flow from your ionizer.



Dust Pre-filter

Parts of the Ionizer - Front



- 1 Water outlet cap
- 2 Flexible steel hose
- 3 Display indicator panel
- 4 Touch button
- 5 Front display panel
- 6 Front case

Parts of the Ionizer - Rear / Base

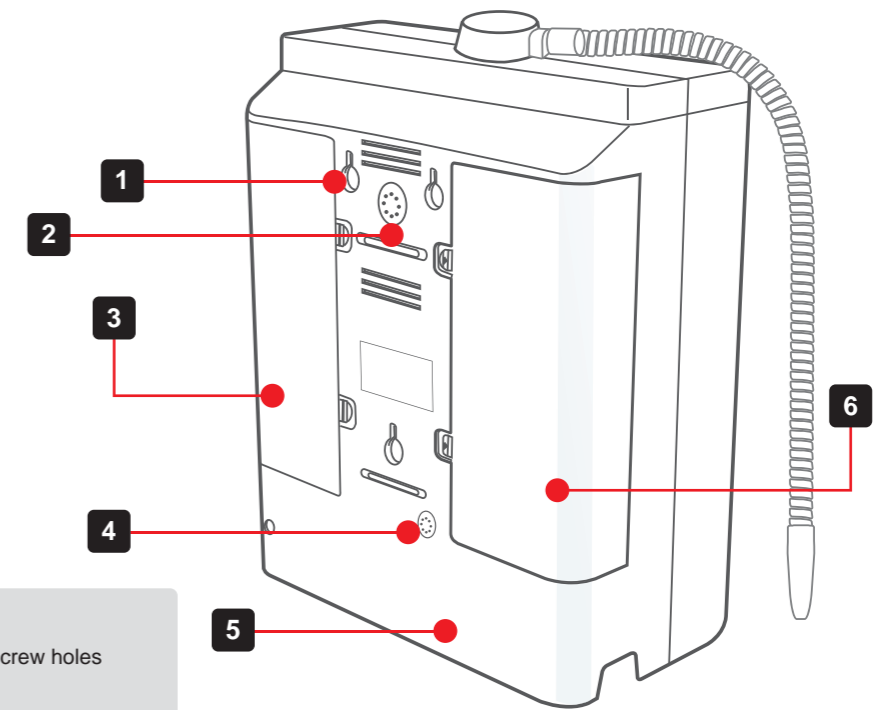

- 1 Wall mount screw holes
- 2 speaker grill
- 3 First Filter cover (1th Filter)
- 4 Under counter installation plug
- 5 Rear case
- 6 Second Filter cover (2nd Filter)

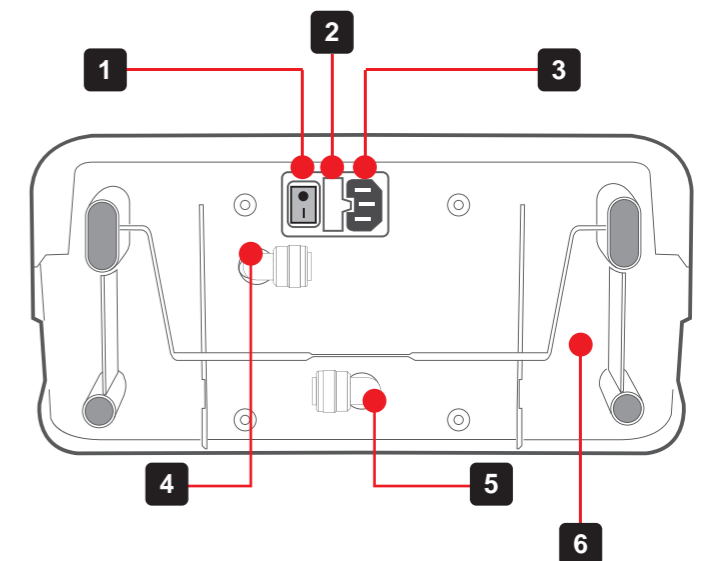

- 1 ON/OFF Power switch
- 2 Fuse box
- 3 Power plug
- 4 Source water inlet
- 5 Acidic water outlet
- 6 Base case

Display & Control Panel Guide

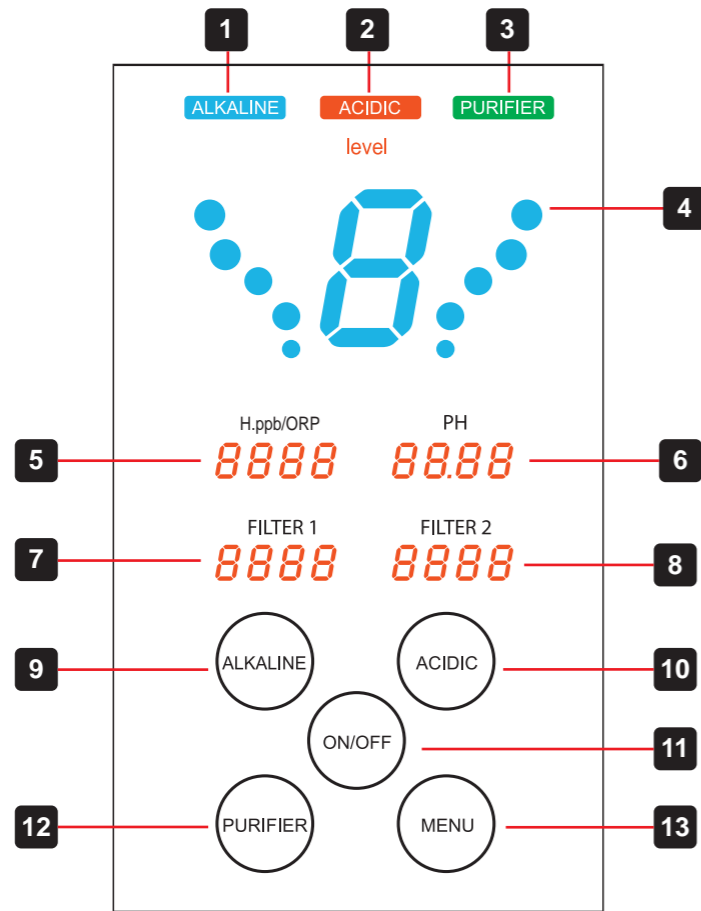

- | | |
|---------------------------------------------|------------------------------------|
| 1 Alkaline Water Indicator Display | 10 Acidic Selector Button |
| 2 Acidic Water Indicator Display | 11 ON/OFF Button |
| 3 Purified Water Indicator Display | 12 Purified Selector Button |
| 4 Level Indicator Display | 13 Menu/Function Button |
| 5 ORP/Hydrogen ion Indicator Display | |
| 6 pH Indicator Display | |
| 7 Filter 1 / Filter Life Indicator | |
| 8 Filter 2 / Filter Life Indicator | |
| 9 Alkaline Selector Button | |

Installation to Faucet(Counter top)

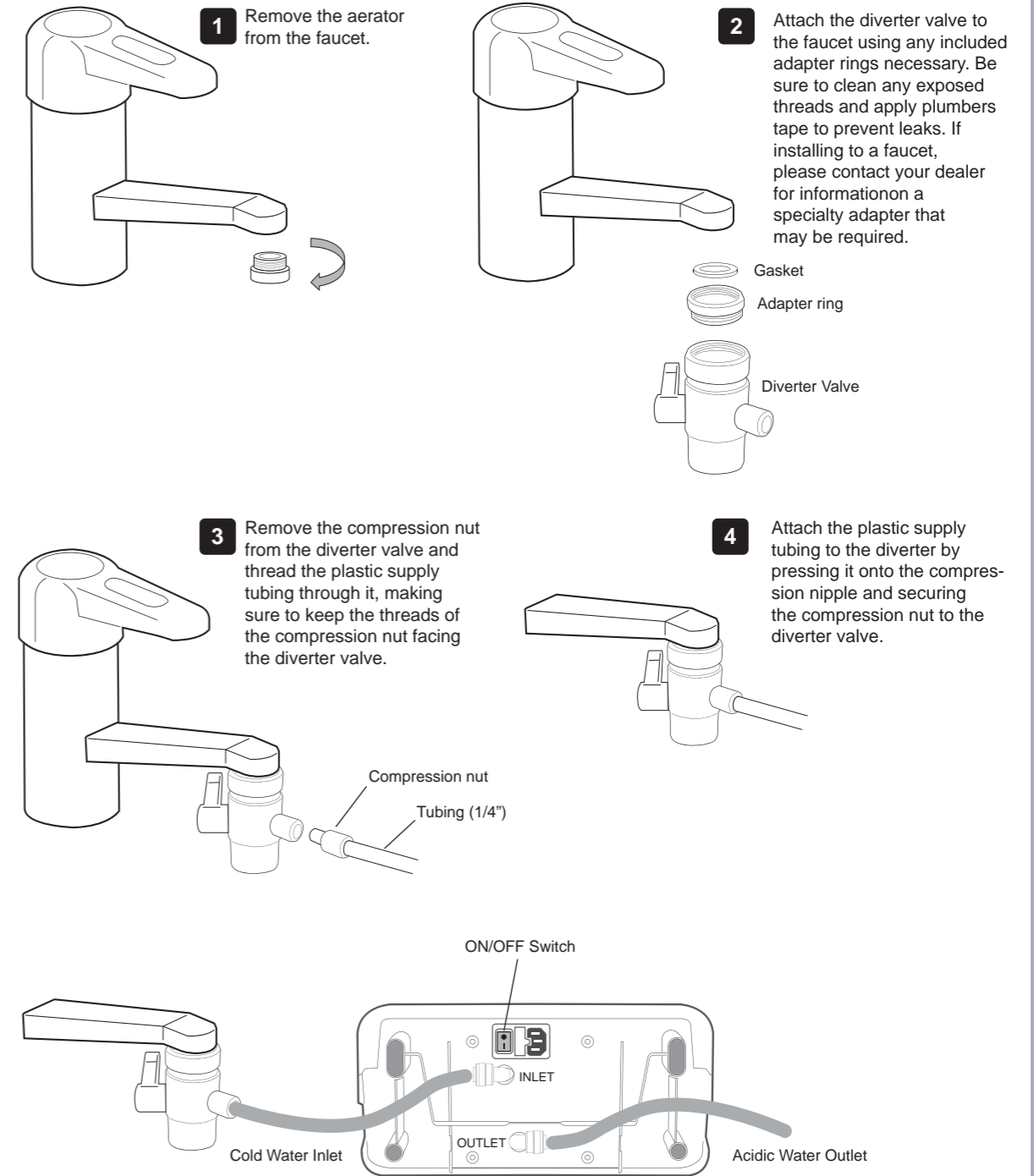

- 5** Connect hoses to the water Inlet and Acidic water Outlet.

Installation Direct to Cold Water Line

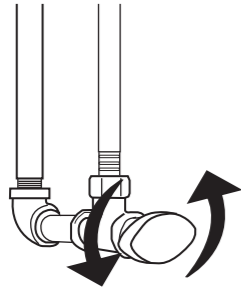

- 1** Find the cold water supply line and close the valve.

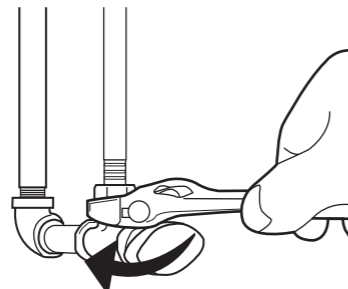

- 2** Disconnect the cold water hose from the line. Make sure it is the cold water hose and not hot because hot water will cause the unit to malfunction.

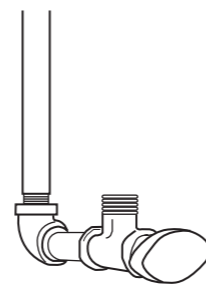

- 3** Separate the water line.

Optional valve

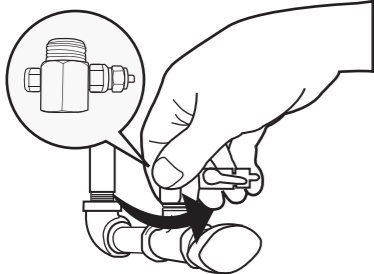

- 4** Connect the cold water line adapter to the cold water supply valve as shown. As fittings vary you will need to find the right size adaptors at your local plumbing store.

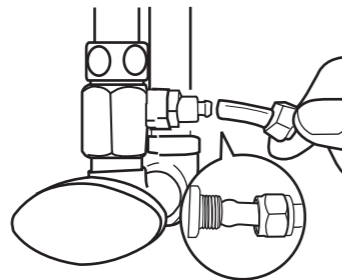

- 5** Connect the plastic tubing as shown.

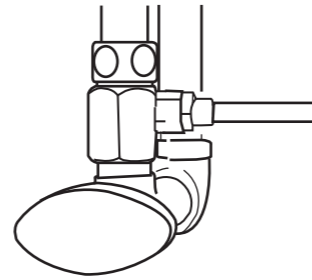

- 6** Connect hoses to the water inlet and acidic water outlet then open the cold water supply valve.

CAUTION

- Be sure the valves are all connected tightly to prevent leakage.
- Be sure of where you want to install the ionizer as a hole needs to be drilled through the sink top to thread the tube.
- Be sure you connect the unit to cold water as hot water can damage the unit.
- This is a good time to double check and make sure all your fittings are tight and the tubing is secure in the fittings.
- Check daily for any leaks during the first week after installation and check for leaks occasionally thereafter.

Operation Method

Alkaline Water discharge method

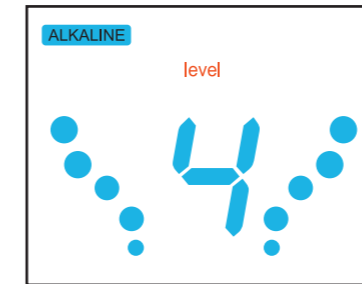

Press the "ON/OFF" button and then select the "ALKALINE" button and tap until the desired Alkaline level displays on the screen. The level indicator will display the level you selected. To STOP collecting water, press the "ON/OFF" button.



1-2-3-4-1-2-3-4

Acidic Water discharge method

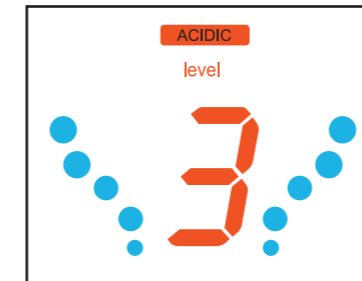

Press the "ON/OFF" button and then select the "ACIDIC" button and tap until the desired Acidic level displays on the screen. The level indicator will display the level you selected. To STOP collecting water, press the "ON/OFF" button.



1-2-3-1-2-3

Purified Water discharge method

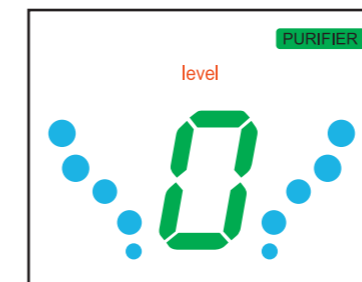

Press the "ON/OFF" button and then select the "PURIFIED" button to start dispensing filtered, Purified water. To STOP collecting water, press the "ON/OFF" button.

Parts of the Faucet (Optional)

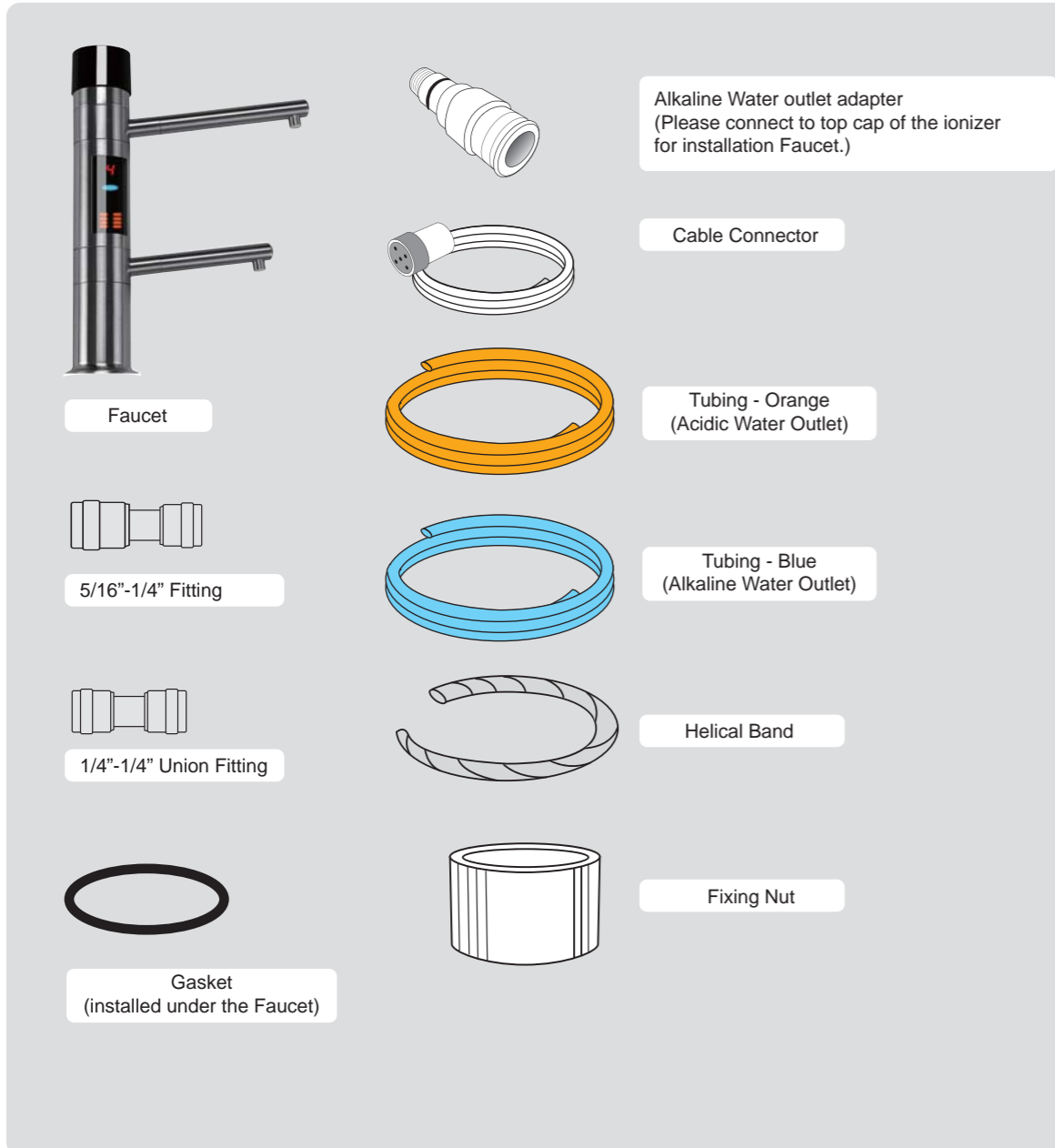

Faucet Display & Control Panel Guide

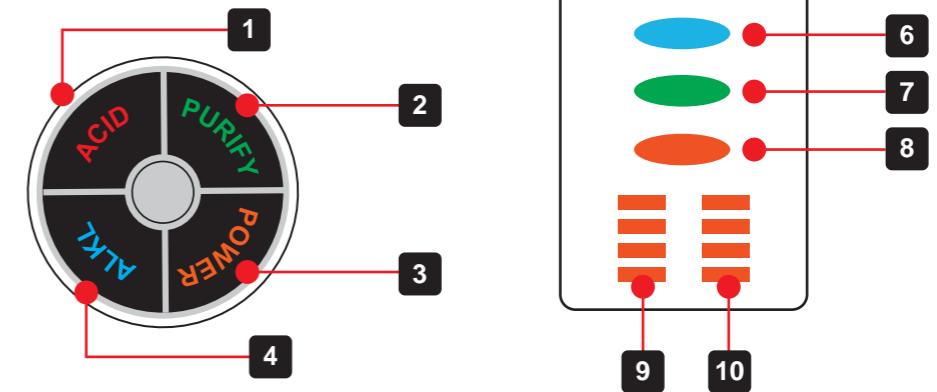
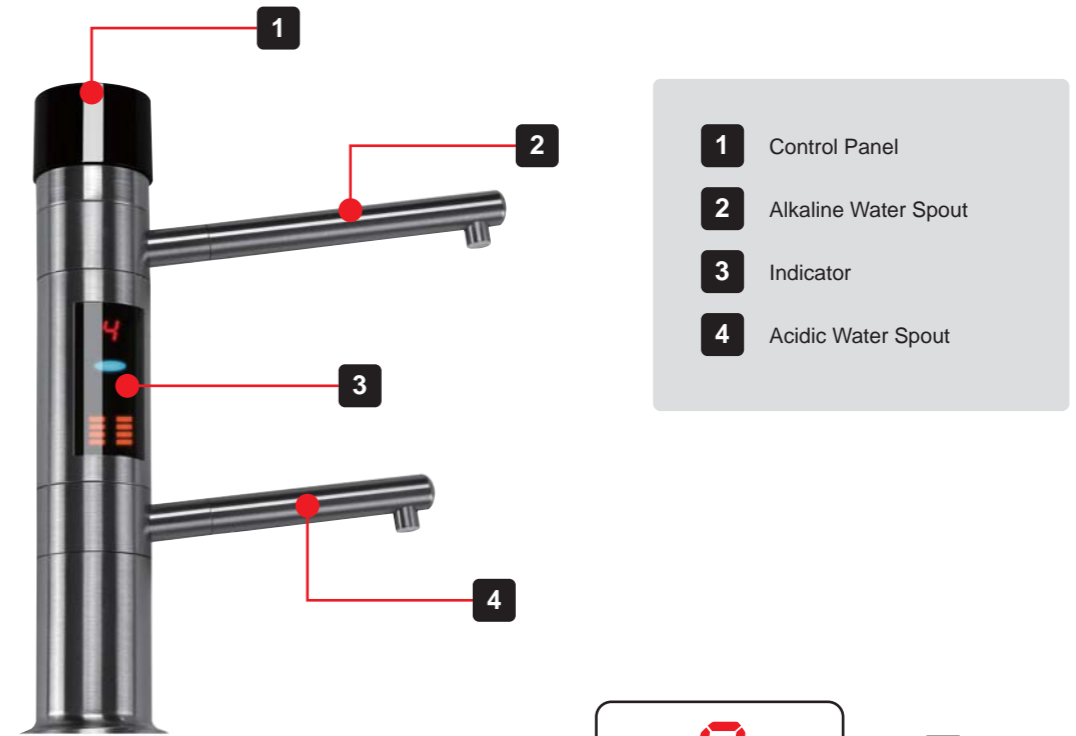

- | | | |
|----------------------------|------------------------------------|-----------------------------------|
| 1 Acidic Selector Button | 5 Level Indicator Display | 9 Filter 1/Filter Life Indicator |
| 2 Purified Selector Button | 6 Alkaline Water Indicator Display | 10 Filter 2/Filter Life Indicator |
| 3 ON/OFF Button | 7 Purified Water Indicator Display | 3 ON/OFF Button |
| 4 Alkaline Selector Button | 8 Acidic Water Indicator Display | 4 Alkaline Selector Button |

Faucet Installation Guide

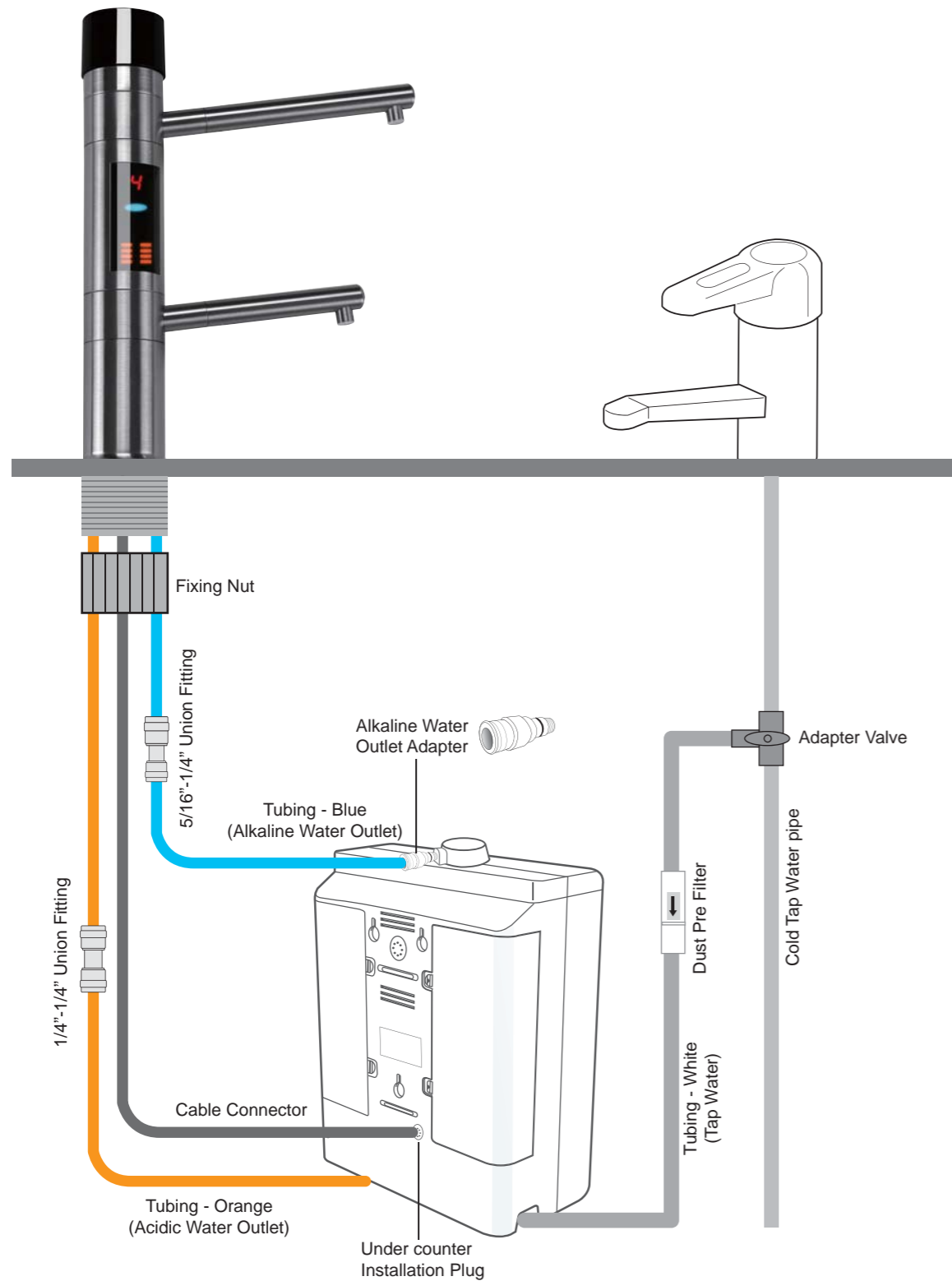

Faucet Installation Guide

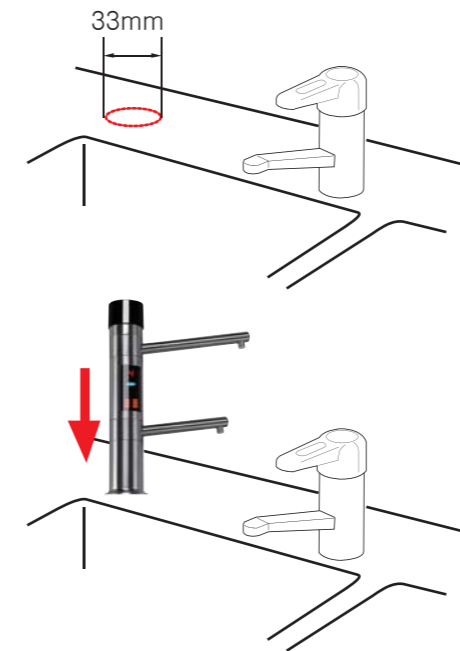

- 1** Use appropriate tools to make 33mm diameter hole in the location where you will set up the faucet. Make sure the faucet location will allow both spouts to reach the sink.
- 2** Insert the faucet in the hole and then screw it with a nut to make it be fixed.
- 3** After the faucet is fixed, connect it to fitting hose (for Alkaline-Blue). Check the hose whether it is inserted properly or not. Also, connect it hose (for Acidic-Orange) connect the faucet to the body.

- 4** Place the Ionizer in an appropriate place under your sink
- 5** Connect the Acidic Water Hose (Orange color) to the 1/4"-1/4" Union fitting on the Acidic Hose extending from the faucet to Acidic Water Outlet on the Ionizer. Pull firmly to check to connection - you should not be able to pull the hose out.
- 6** Connect the Alkaline Water Hose (Blue color) attached to the threaded stem of the faucet to the Alkaline Water Outlet on the ionizer. Pull firmly to check to connection - you should not be able to pull the hose out.
- 7** Install the dust pre-filter in the middle of a length of 1/4 inch hose with the arrow pointed at the ionizer. Connect the 1/4 inch hose with dust filter to Tap Water Inlet on the bottom of the ionizer. Pull firmly to check to connection - you should not be able to pull the hose out.
- 8** Join the cable connector from the faucet to the Connect Wire. Plug the Connector Cord into the Connector Plug on the back of the ionizer.
- 9** Connect the power cord into an appropriate outlet.

Faucet Operation Method

Alkaline Water discharge method



Press the "ON/OFF" button and then select the "ALKL" button and tap until the desired Alkaline level displays and light is marked by blue color on the screen.
The level indicator will display the level you selected. To STOP collecting water, press the "ON/OFF" button.

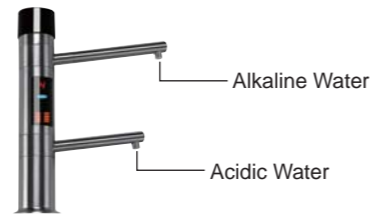
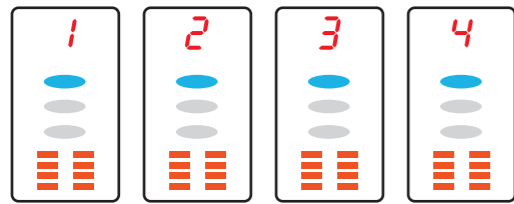

Acidic Water discharge method



Press the "ON/OFF" button and then select the "ACID" button and tap until the desired Acidic level displays and light is marked by orange color on the screen.
The level indicator will display the level you selected. To STOP collecting water, press the "ON/OFF" button.

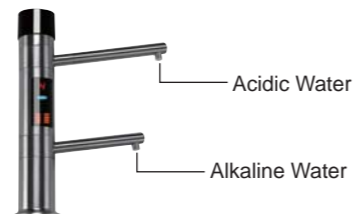
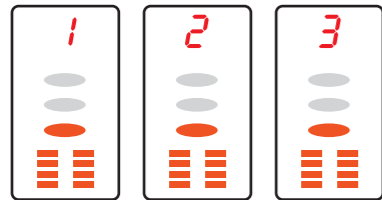

Purified Water discharge method



Press the "ON/OFF" button and then select the "PURIFY" button to start dispensing filtered, Purified water.
To STOP collecting water, press the "ON/OFF" button.

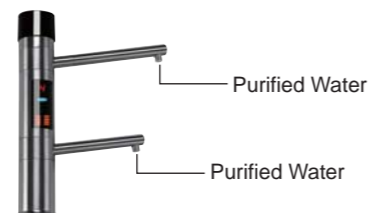

Internal Filter Replacement

Countertop Filter Life

FILTER 1
0000 FILTER 2
0000

When the digital filter life indicator reaches "0000" or 1 bar only, it is time to replace your filter

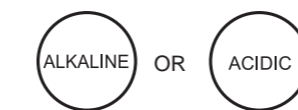
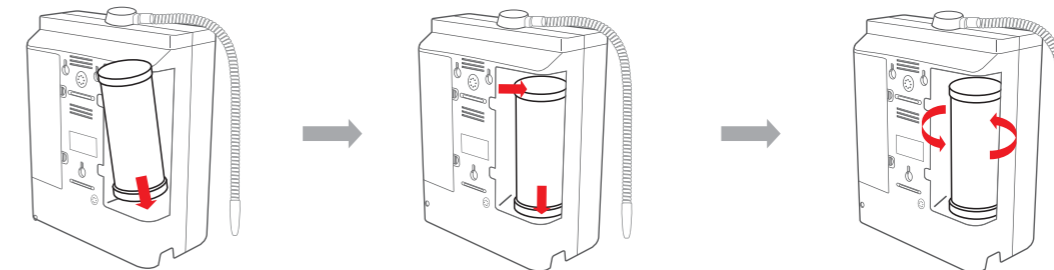
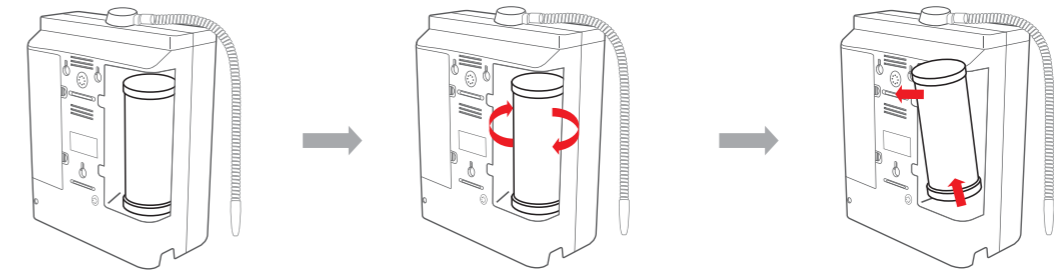

1. After changing the first filter, press and hold the "FILTER 1" button for 3~5 seconds. You will hear 2 beeps and the filter counter indicator will reset to 3000.
2. After changing the second filter, press and hold the "FILTER 2" button for 3~5 seconds. You will hear 2 beeps and the filter counter indicator will reset to 5000.

1st Filter Reset 2nd Filter Reset

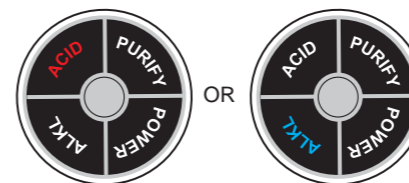

1st Filter Reset 2nd Filter Reset

1. After changing the first filter, you can reset it by pressing and holding the "ACID" button for 10 seconds and you will hear 2 beeps.
2. After changing the second filter; you can reset it by pressing and holding the "ALKL" button for 10 seconds and you will hear 2 beeps.

Tips After Filter Replacement:

- 1) Select the "Purified Water" setting and let the water run for 3-5 minutes after any filter replacement .
- 2) If the machine has not been used for a few days, let the water run for 3-5 minutes at the "Purified Water" setting before making Ionized Alkaline water for consumption.
- 3) Consult with the installer or retailer on the purchase of filters if in question about usage or installation.

Undercounter Filter Life

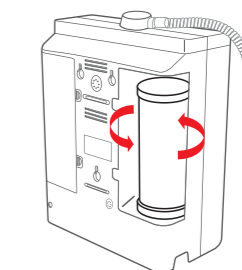
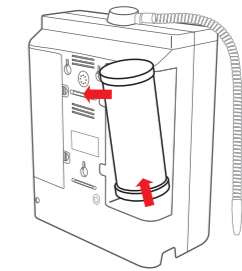

Filter Composition



Tourmaline

Tourmaline emits Far Infra Red (FIR) energy naturally. FIR produces well documented health benefits and it also has an amazing effect on water. The Biostone contains the semi-precious gemstone tourmaline in ceramic form, so you get FIR on tap!

Vitamin Ball (remove chlorine)

Slightly increases the alkaline mineral content of your water and improves the taste of water. Helps also to eliminate chlorine.

Granular Activated Carbon (GAC)

The workhorse of the filtration media. GAC is especially effective at removing chlorine, its odor and taste, agricultural chemicals, phenol, trihalomethane and other chemical contaminants. Silver is coated on the surface of the granular activated carbon to inhibit bacterial growth in between use.

Fiber Filter

Filters out rust and other large particulate matter from water.



Common Problems and Solutions

Condition	Possible Problem	Solutions
<ul style="list-style-type: none"> The power light is not on or the power switch doesn't seem to work. 	<ul style="list-style-type: none"> Unit may not be plugged in correctly. Unit may be plugged into an outlet controlled by a switch. Fuse at the bottom of the machine may be blown. 	<ul style="list-style-type: none"> Make sure power plug is plugged into outlet correctly. Plug unit into an outlet that is constantly 'hot'. Replace the fuse at the bottom of the unit.
<ul style="list-style-type: none"> Water volume is low or doesn't come out of the unit. 	<ul style="list-style-type: none"> Angle Valve Adapter and/or cold water supply are turned off. One or more of the water supply tubes is crimped. House water pressure is too low. Pre-filter and/or unit filters are blocked. 	<ul style="list-style-type: none"> Make sure all water supply valves are open. Check all hoses and tubes. Water pressure may be low for many reasons (RO system, sprinkler system, etc) Call your dealer support for assistance. If unit has been used for 6 months or more, replace filters as needed.
<ul style="list-style-type: none"> Tubing is leaking. 	<ul style="list-style-type: none"> Tube is not seated properly or there is a hole in the tubing. 	<ul style="list-style-type: none"> Disconnect and reconnect tubing making sure it is seated 3/4 inch deep or replace tubing.
<ul style="list-style-type: none"> Pre-filter is leaking. 	<ul style="list-style-type: none"> Tubing to pre-filter is not seated deeply enough. O-Rings inside the pre-filter are not seated correctly or are being crimped due to housing cover being on too tight. 	<ul style="list-style-type: none"> Disconnect and reseal tubing at least 3/4 inches into filter. Disconnect tubing and unscrew housing cover. Make sure O-Rings are seated properly.
<ul style="list-style-type: none"> Water has an unpleasant odor or taste. 	<ul style="list-style-type: none"> The internal filters may need to be replaced. Water source requires a pre-filter or RO filter. 	<ul style="list-style-type: none"> Call your dealer to place an order for new filters. Call your dealer for a water quality report for your area.
<ul style="list-style-type: none"> Unit is making an unusual noise. 	<ul style="list-style-type: none"> The problem is internal and requires a qualified technician. 	<ul style="list-style-type: none"> Unplug the unit from the power source and call Technical Support.
<ul style="list-style-type: none"> Ionizer is leaking. 	<ul style="list-style-type: none"> The problem is internal and requires a qualified technician. 	<ul style="list-style-type: none"> Unplug the unit from the power supply and call Technical Support.
<ul style="list-style-type: none"> Even though the filter has been replaced, the filter life indicator still shows no-life. 	<ul style="list-style-type: none"> Did you reset the filter counter? 	<ul style="list-style-type: none"> Reset the filter by pressing the filter replacement button.

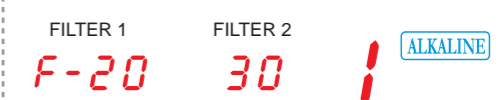

Product Specification

Product Type	Alkaline Water Ionizer
Model Name	Prime 501L / Prime 701L / Prime 901L / Prime 1101L / Prime 1301L
Dimensions	33cm X 34.7cm X 15cm
Unit Weight	6.5 Kg
Maximum Water Supply Pressure	50 psi
Applicable Water Temperature	5~30 degree (41~86 F)
Electrolysis Method	Continuous Electrolysis
Cleaning Method	Automatic & Manual
Plate Materials	Platinum Titanium
Plate Number	Prime 501L (5) / Prime 701L (7) / Prime 901L (9) Prime 1101L (11) / Prime 1301L (13)
Plate Type	Mesh
Flow Control	Automatic
Alkaline Setting	1-2-3-4
Acidic Setting	1-2-3
Purified Setting	1
Ionized Water Output Rate	Max 3 Liters / 1 min
Rated Voltage	110V, 220V
Power Consumption	Prime 501L (300W) / Prime 701L (450W) / Prime 901L (450W) Prime 1101L (450W) / Prime 1301L (450W)
Power Supply Device	SMPS
Display	Full Color LED
Filter Life Indicator	FND Number Indicator
Filter Number	Dual Filter (2 Filters)
Filter Replacement	Cartridge
Filter Life	6 Month (20 Liters / 1 day)
Filter Composition	Activated Carbon, Vitamin Ball, Fiber Filter, Ceramic Ball

Function Option Guide

Function Code	Description	Display Shows
F-10	<p>Volume Adjustment</p> <p>Hold Down the "MENU" button for 5 seconds until the menu option appears on screen. To increase volume, press "Alkaline" to decrease volume press "Acidic" To save adjustment, press "Menu" button.</p>	 <p>0(MUTE)-1-2-3-4-5-6-7(MAX)</p>
F-20	<p>Voltage Adjustment</p> <p>Hold down the "Menu+ACIDIC" button for 5 seconds until the menu option appears on screen.</p> <ul style="list-style-type: none"> Press Alkaline Button until the Alkaline symbol appears and flashes. To increase Voltage, press "Alkaline" to decrease Voltage, press "Acidic" . Same process is used for adjusting the Acidic level. To save adjustment, press "Purified" button. 	  <p>Alkaline Water Set Voltage range : 1 ~ 240 Acidic Water Set Voltage range : 1 ~ 240</p>

Error Messages

Error Code	Description	Solutions
ER-1	 <p>Low Water Pressure : Water flow from unit is too low</p>	<ol style="list-style-type: none"> Increase the input water. Water flow sensor malfunction : Replace the water flow sensor.
ER-2	 <p>Leaking Problem : When the unit not working, water output from flexible hose or faucet spout.</p>	<ol style="list-style-type: none"> Inlet Solenoid valve malfunction (no working) : Replace the solenoid valve. Water flow sensor malfunction : Replace the water flow sensor.

Explanation of Ionized Water

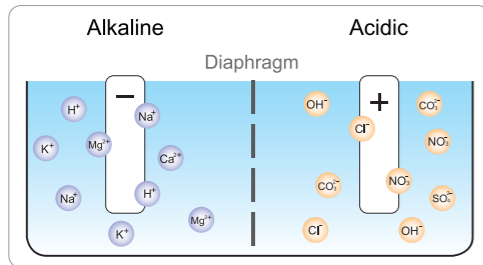

During electrolysis, the cathode has a negative charge and produces alkaline ionized water (pH range 7.5~10) with negatively charged hydroxyl ions, and attracts alkaline minerals - such as calcium, potassium, magnesium, and sodium.

The anode has a positive charge and produces acidic ionized water (pH range 3.5~6.5) with positively charged hydroxide ions and attracts acidic minerals – such as chlorine, sulphur, phosphorus.

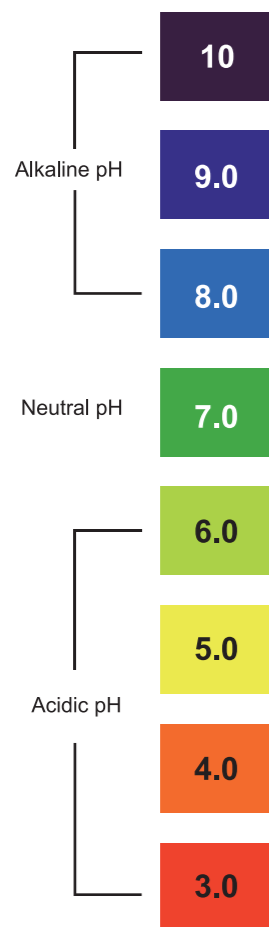

What is pH?

On the pH scale, which ranges from 0 on the acidic end to 14 on the alkaline end, a solution is neutral if its pH is 7. At pH 7, water contains equal concentrations of H⁺ and OH⁻ ions. Substances with a pH less than 7 are acidic because they contain a higher concentration of H⁺ ions. Substances with a pH higher than 7 are alkaline because they contain a higher concentration of OH⁻ than H⁺. The pH scale is a log scale so a change of one pH unit means a tenfold change in the concentration of hydrogen ions.

The scale that is used for measuring the pH, or hydrogen ion concentration ... is from 0 to 14, with 7 being the neutral point. Below 7 is acidic; above 7 is alkaline. The optimal pH of the body's fluids, such as the blood is 7.4, slightly alkaline. If deviated from this range ... the bodies activity is no longer optimal and the metabolism is out of balance as the body will begin to store toxins in fat and move around acidic material to keep the blood PH in balance.

The pH of the body is largely influenced by metabolic byproducts and our diet. Thus, pH is directly affected by the various categories of food that we eat and the internal mechanisms involved in their processing. Some foods that are acid in their composition can become alkalizing following metabolizing by the body, such as lemons. Accordingly, it is to become more aware of the impact that various foods and our eating habits have on the internal environment of the body.

From a lot of reading, this is my take on the subject. First, your body has natural protectors to keep your blood pH in its optimal range. However, to do this, other things might have to give. Perhaps if you are super acidic, you retain more weight because your body stores excess acid that it could not get rid of by natural means, in fat cells.

Also, stay "alkaline" does not mean that you have to only eat foods that have an alkaline forming effect on your body. What it means, is that you need to consumer slightly more alkaline forming food to match with your body working to maintain a slightly alkaline state as well.

Alkaline & Acidic Water Usage Guide

Alkaline Water Usage Guide

1. If the machine has not been used for several days, let the water run on the "Purified Water" setting for at least 3-5 minutes before any operation.
2. First time users who are not familiar with this water are recommended to start with Ionized Alkaline Water level 1 and adjust the quantity or level of wate which might fit you the best. Increase slowly over time as your body adjusts. (Level 1 is recommended for first time Alkaline Ionized water drinkers).
3. Store Ionized Alkaline Water in an airtight glass container and put it in a refrigerator for no longer than 2 days for maximum benefit. The first 12 hours after ionization the water is most effective.

Acidic Water Usage Guide

Acidic water is not drinkable – DO NOT DRINK

1. Use acid water only for disinfecting, cleaning, plants and as a face/skin toner.
2. Acidic water properties are the best 1-7 days after ionization if it is put in an airtight glass container and kept refridgerator.

Purified Water Usage Guide

1. Drink purified water with meals to allow your stomach acid to do its work digesting your food.
2. It is best to drink purified water when taking medication.
3. Can a person drink Ionized Alkaline Water when on medication?
-Yes, as a precaution DO NOT DRINK Ionized Alkaline Water 45 minutes to one hour before and after taking medication or supplements.
4. Children: Use purified water when preparing baby food.

Please note that water will come out of both spouts when dispensing water.

- A) When the Alkaline button is pressed, Alkaline water will be dispensed from the top spout and acid water will be dispensed from the bottom spout.
- B) When the Acid button is pressed, Acid water will be dispensed from the top spout and Alkaline water will be dispensed from the bottom spout.
- C) When the purify button is pressed, purified water will be dispensed from the bottom and top spouts.

Uses for Ionized Alkaline Water

Highly Ionized Alkaline Water: pH 11.0+

Highly Ionized Alkaline Water is useful for cleaning and preparing food.

- Food Preparation : Wash Vegetables and fruit.
- Cleaning : Clean cutting boards with. Good for cleaning oil and tough grime from vents, as well as for general cleaning in the kitchen.
- Stain Removal : The extra strength, absorption power will remove coffee, soy sauce and oil stains with ease. Also great for getting out stubborn toilet bowl stains.
- Dishes : Use less detergent when hand washing dishes. Save on water bills, as only one-third to one-fourth of the usual amount of water is adequate cleaning and for rinsing with detergent.

Alkaline Water: pH 8.0 ~ 10.0

- For drinking, food preparation, watering plants, health maintenance.
- Drinking : Drink at least eight 8 ounce glasses of water every day. Alkaline water is part of a healthy diet.
- Food Preparation : Clean vegetables and fish. Enhance the flavor of broccoli, onions, etc. by pre-boiling them in Ionized Alkaline Water. Use less condiments and salt in your diet.
- Rice : Use Ionized Alkaline Water for washing and cooking rice. The result is delicious and fluffy rice.
- Tea : Taste and aroma are everything to many people. You will be surprised at the improved color, taste, and aroma. You can use less tea and still achieve a full rich taste.
- Soups and Stews : Ionized Alkaline Water draws out the flavor of ingredients so they get tender and juicy. Therefore, less seasoning such as salt and soy sauce are needed. This water is good for people who want to reduce their salt intake.
- Plants : Watering plants and flowers. Ionized Alkaline Water extends the freshness and life of plants. Ionized Alkaline Water with a pH level of 9.0 can also restore the health of sick plants. Ionized Alkaline Water stimulates germination and improves seeding development.
- Animals : Give purified water with food. Just like humans, animals should not drink alkaline water for an hour before, during, or an hour after meals.
- Crafts : Excellent for dyeing cloths, as well as other craft projects. You will love the vibrant colors obtained when using this water.
- Health : Through continuous use, the acidic tendency of your body can be gradually corrected to an Alkaline levels. Drink at least half your body weight in ounces

Purified Water: pH 7.0

Free of chlorine, rust and cloudiness. Clean water is delicious drinking water.

- Children : Use purified water with a pH of 7.0 when preparing baby food.

Uses for Acidic Water

Acidic Water pH 4.0~6.0

- Face wash : The astringent properties of acidic water are effective in toning and firming your skin. Pat the skin and leave to dry. This water is also excellent as a toner after shaving.
- Hair Care : Use this water to rinse your hair after shampooing. Reduces annoying tangles and brings out a radiant shine. Keep in a spray bottle and spray your hair and face when you're out and about.
- Bath Water : Add acidic water to your bath water to keep your tub free of bathtub rings. Bathing in this water gives your body a warm and comfortable feeling.
- Pet Care : Spray your pet with this water and brush afterwards to obtain soft and shiney fur. Great for grooming your pet!
- Rinse Cycle : Soaking with acidic water before the spin cycle will soften your clothes.
- Cooking beans : Various types of beans, such as kidney beans and green peas, will cook to perfection. Just be careful not to overcook your beans. Acidic water will speed up the cooking time! This is energy saving water!
- Fried Food : Fried food comes out nice and crispy if you rinse it in acidic water before frying.
- Frozen food : Spray foods with acidic water when freezing so that the food, including fish and shrimp, does not lose its flavor when thawed.
- Stains : To remove stains, grime and grease, leave to soak in water for 24 hours.
- Dishes : Dishes and glasses come out sparkling clean.
- Polishing : Polish mirrors, eyeglasses, glass objects and windows to a high sheen.
- House Cleaning : Remove dirt from hardwood floors, ceramic tiles, etc. without leaving a sticky residue.

Frequently Asked Questions

Q What should I expect from drinking Ionized Alkaline Water?

A Everybody's body is different, but typically new alkaline water drinkers say they see or feel effects in a week or two. You will notice a difference in taste: Ionized Water is much smoother tasting than conventional water. It makes better coffee, tea, juice, etc.

Q Who should drink Ionized Alkaline Water?

A People and pets can drink Ionized Alkaline Water.

Q Is there anyone who should not drink Ionized Alkaline Water?

A Some people must start by drinking very small amounts of Ionized Alkaline Water, such as 8 oz. of strength level 1 (one) per day. Children 3 years and younger should not drink Ionized Alkaline Water. They may only drink the purified water from the Ionizer. Children between the ages of 4 years and 12 years should only drink Ionized Alkaline Water at strength level 1 (one) and strength level 2 (two). Children between the ages of 4 and 12 years of age should never drink Ionized Alkaline Water at strength level 3 (three) or strength level 4 (four).

Q Should I take medication or supplements with Ionized Alkaline Water?

A Due to the superior quality of ionized, alkaline, water and its enhanced hydration capabilities, we do not recommend its use for 30 minutes before and after with prescription or over the counter medications. However, we highly recommend its use with vitamins, supplements, nutritional powders and other nutraceuticals because of its superior quality and enhanced absorption capabilities.

Q Can a person become too Alkaline from drinking Ionized Alkaline Water?

A People have been known to drink as much as 1 to 2 gallons of Ionized Water every day without a problem. It is rare for a person to acquire Alkalosis, the condition of being too Alkaline.

Q How much water should I drink and at what level?

A At a minimum, you should drink half your bodyweight in ounces per day. For example, a person weighing 100 pounds should drink 50 ounces. You should start slow at strength Level 1 (one), drinking 1-3 glasses per day for the first week. You may increase the number of glasses per day during the first week if you do not notice any side effects. If you do not feel any flu-like symptoms at the end of the first week, move up to strength Level 2 (two). On strength Level 2 (two), drink 1-3 glasses per day for the first week. You may increase the number of glasses per day during the first week if you're feeling good. On average, two to three weeks per level; work your way up to a 10.5 pH (strength Level 4 (four)).

Frequently Asked Questions

Q Why do some people have flu like symptoms when first drinking Ionized Alkaline Water?

A If you start drinking Ionized Alkaline Water at too high of a strength level (high pH level) then you might notice flu like symptoms. These symptoms are mild and they clear up in about a week. This effect is typically noticed by people whose bodies have accumulated toxins in them.

Q How does Ionized Alkaline Water affect athletes?

A Many athletes alkalize their bodies prior to working out. Alkaline water can help. Additionally, drinking alkaline water during workouts is a great way to stay hydrated. Numerous studies conducted on athletes since the 1940s have demonstrated that even mild dehydration impairs performance. Dr. Peter L. Kopko, D.C., recommends drinking 13 to 20 ounces (2-3 cups) of water 2 hours before exercise and 5 to 10 ounces (about 1-2 cups) every 15 to 20 minutes of exercise, depending on your total body weight.

Q How long does Ionized Alkaline Water stay Ionized?

A The Antioxidant (hydroxyl ions) will last approximately 18-24 hours. The Higher pH (Alkaline properties) will last approximately 1-2 weeks.

Q Does Ionized Alkaline Water have any negative effects?

A Absolutely none, as long as it is used properly. Only the Ionized Alkaline Water should be consumed. NEVER DRINK THE ACIDIC WATER.

Q How do I know when the filter needs replacing?

A An LED or counter indicator on the front panel gives an indication of remaining filter life. Generally the 1st filter will last for about 8 months, the 2nd filter for about 12 months (when up to 2.5 gallons of water is produced per day), but this depends on the source of water and the amount of use. For example, if your tap water contains between 0.4 and 1.0 ppm (parts per million) of chlorine, a filter can last 12 months for one person's use. If greater than 1.0 ppm, the filter may last 8 months. By changing your filters at regular intervals at least once a year, you are assured of the quality of your water.

Q What should be done if the machine is not to be used for 7 days or more?

A Remove the filter from the main body, wrap in plastic wrapping, and store in a refrigerator. Remove the power plug. When ready to use again, install the filter and run in the Ionizer in the 'PURIFIED' mode for approx. 3 minutes before using the water.

Frequently Asked Questions

Q There are white substances on the bottom of my Alkaline Ionized water storage container. What are these?

A This phenomenon is caused by the calcium mineral substances in Alkaline Ionized water. Particularly, if the carboxyl group (CO₃) is present, it will bind to the calcium carbonate (Ca CO₃), creating such substances. This is apparent evidence of electrolysis. Although it is safe to drink, wash the container - add one spoon of edible vinegar and water to the container, leave the container for approximately 1 hour, and wash the container.

Q What do I do if the filters are leaking?

A It is important to note where on the filter it is leaking. Most leaking comes from fittings that are not seated properly. Reseat the tubing into the filter by pushing in firmly and then pulling back. It may be necessary to re-trim the end of the tubing to get a fresh surface. Make sure to shut off the water before working with the water supply lines.

Q Where is the serial number located?

A On the back of the ionizer, you will see a bar code sticker. The serial number is located below the bar code.

LIMITED WARRANTY INFORMATION

This warranty is extended only to the original purchaser

Congratulations on your new purchase!

- TODAY'S DATE :
 - NAME :
 - ADDRESS :
 - CITY :
 - STATE :
 - DATE OF PURCHASE :
 - MODEL & SERIAL NUMBER :
 - CONTACT PHONE NUMBER :
 - DEALER PURCHASED FROM :
-

This warranty only covers failures due to defects in materials and workmanship which occur during normal use.

This warranty does not cover damage which occurs in return shipment, failures which are caused by products not supplied by the warrantor, damage due to mineral build-up, failures which result from accident, misuse, abuse, neglect, mishandling, faulty installation, misapplication, improper insertion of consumables, set-up adjustments, maladjustment of consumer controls, improper operation or maintenance, alteration, modification, power line surge, improper voltage supply, commercial use, or service by another other than an authorized repair facility.

Limits & Exclusions

There are no express warranties except as listed above.

The warrantor is not responsible for incidental or consequential damage; for damages arising out of the use of any unauthorized attachment; or for damages arising out of the product with a defective water faucet.

This warranty does not cover repairs caused by customer neglect or by failure to stop the mineral build-up such as calcium in hard water areas.